

Product Specification

SFP+ 10G WDM ER 60km LC TX1270 Transceiver

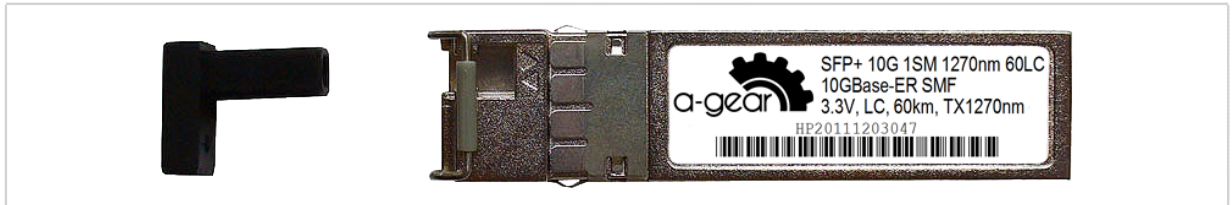

1. Features

- Up to 10.7Gbps Data Links
- Single Mode LC Receptacle
- Up to 60km transmission on SMF
- Power dissipation < 1.5W
- 1270nm DFB laser and APD receiver
- 2-wire interface with integrated Digital Diagnostic monitoring
- EEPROM with Serial ID Functionality
- Compliant with SFP+ MSA with duplex LC connector
- Single + 3.3 V Power Supply and LVTTTL Logic
- Case operating temperature: -5°C ~ +70°C

2. Applications

- 10GBASE-BX at 10.3125 Gb/s
- 10GBASE-BX at 9.953 Gb/s

3. Standard

- Compliant with SFF-8472 SFP+ MSA
- Compliant to SFP+ SFF-8431 and SFF-8432
- RoHS Compliant

4. Product Description

SFP+ 10G WDM ER 60km LC TX1270 is hot pluggable 3.3V Small-Form-Factor transceiver module. It designed expressly for high-speed communication applications that require rates up to 10.7Gb/s, it designed to be compliant with SFF-8472 SFP+ MSA. The module data link up to 60km in 9/125um single mode fiber. The optical output can be disabled by a LVTTTL logic high-level input of Tx Disable. Tx Fault is provided to indicate that degradation of the laser. Loss of

signal (LOS) output is provided to indicate the loss of an input optical signal of receiver or the link status with partner.

5. Absolute Maximum Ratings

Rating	Symbol	Min.	Max.	Units
Storage Temperature	T _s	-40	85	°C
Storage Ambient Humidity	HA	5	95	%
Operating Relative Humidity	RH	-	85	%
Power Supply Voltage	V _{cc}	-0.3	4	V
Signal Input Voltage		V _{cc} -0.3	V _{cc} +0.3	V

6. Recommended Operating Conditions

Parameter	Symbol	Min.	Typical	Max.	Units
Case Operating Temperature	T _{case}	-5	-	70	°C ^[2]
Power Supply Voltage	V _{cc}	3.14	3.3	3.47	V
Power Supply Current	I _{cc}	-	300	450	mA
Data Rate	BR		10.3125		Gbps
Transmission Distance	TD		-	60	km ^[1]
Coupled fiber					Single mode fiber ^[3]

Notes:

- [1] Measured with SMF
- [2] Without air flow
- [3] ITU-T G.652

7. Optical Characteristics

Parameter	Symbol	Min.	Typical	Max.	Unit
Transmitter					
Average Launched Power	P _O	1	-	5	dBm
Average Launched Power (Laser Off)	P _{off}	-	-	-40	dBm ^[1]
Center Wavelength Range	λ _C	1260	1270	1280	nm
Side mode suppression ratio	SMSR	30	-	-	dB
Spectrum Bandwidth(-20dB)	σ	-	-	1	nm
Extinction Ratio	ER	3.5		-	dB ^[2]
Output Eye Mask					Compliant with IEEE 0802.3ae ^[2]

Parameter	Symbol	Min.	Typical	Max.	Unit
Receiver					
Input Optical Wavelength	λ_{IN}	1320	1330	1340	nm
Receiver Sensitivity	Psen	-	-	-20	dBm ^[3]
Input Saturation Power (Overload)	PSAT	-6	-	-	dBm ^[3]
LOS -Assert Power	PA	-35	-	-	dBm
LOS -Deassert Power	PD	-	-	-21	dBm
LOS -Hysteresis	PHys	0.5	-	5	dB

Notes:

- [1] The optical power is launched into SMF
- [2] Measured with RPBS 2³¹-1 test pattern @10.3125Gbs
- [3] Measured with RPBS 2³¹-1 test pattern @10.3125Gbs BER=<10⁻¹²

8. Electrical Interface Characteristics

Parameter	Symbol	Min.	Typical	Max.	Unit
Total power supply current	I _{CC}	-	300-	450	mA
Transmitter					
Differential Data Input Voltage	V _{DT}	180	-	700	mVp-p
Differential line input Impedance	R _{IN}	85	100	115	Ohm
Transmitter Fault Output-High	V _{FAULTH}	2.4	-	V _{CC}	V
Transmitter Fault Output-Low	V _{FAULTL}	-0.3	-	0.8	V
Transmitter Disable Voltage- High	V _{DISH}	2	-	V _{CC} +0.3	V
Transmitter Disable Voltage- Low	V _{DISL}	-0.3	-	0.8	V
Receiver					
Differential Data Output Voltage	V _{DR}	300	-	850	mVp-p
Differential line Output Impedance	R _{OUT}	80	100	120	Ohm
Receiver LOS Pull up Resistor	R _{LOS}	4.7	-	10	KOhm
Data Output Rise/Fall time	tr/tf		-	38	ps
LOS Output Voltage-High	V _{LOSH}	2	-	V _{CC}	V
LOS Output Voltage-Low	V _{LOSL}	-0.3	-	0.4	V

9. Pin Description

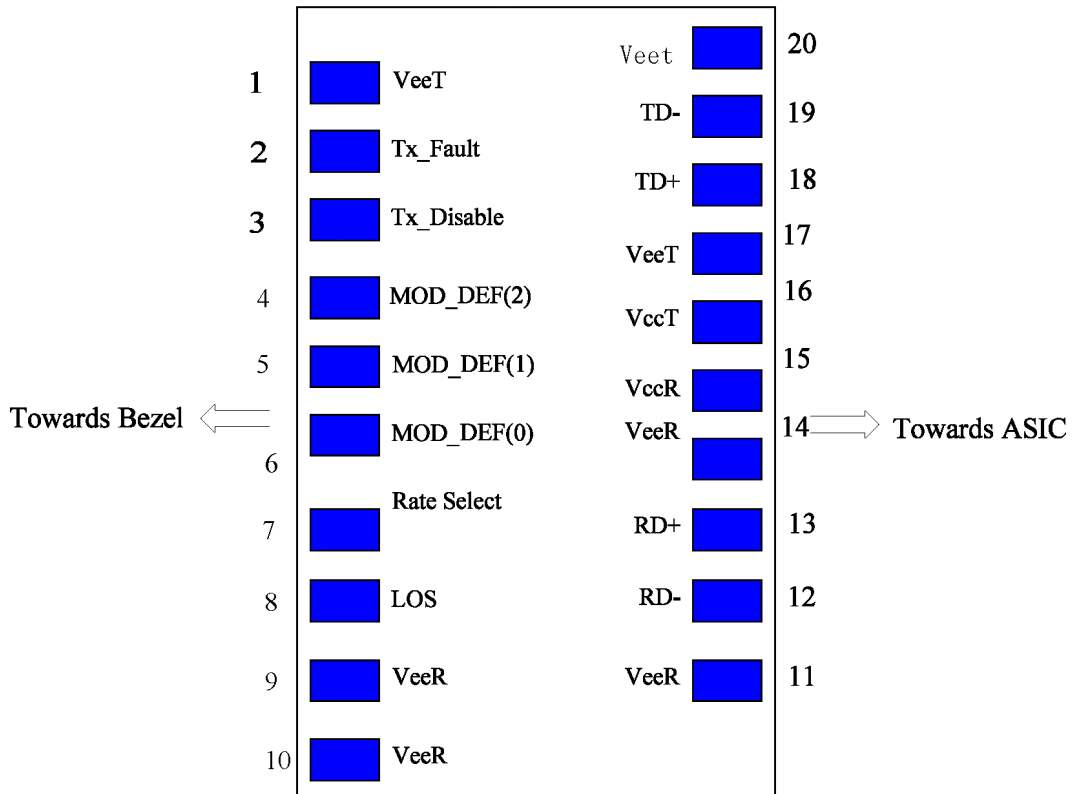

9.1. Diagram of Host Board Connector Block Pin Numbers and Name

Pin	Symbol	Name/Description
1	VeeT	Transmitter Ground (Common with Receiver Ground) [1]
2	T _{FAULT}	Transmitter Fault [2]
3	T _{DIS}	Transmitter Disable. Laser output disabled on high or open [3]
4	SDA	2-wire Serial Interface Data Line [4]
5	SCL	2-wire Serial Interface Clock Line [4]
6	MOD ABS	Module Absent. Grounded within the module [4]
7	RS0	Rate Select 0 [5]
8	LOS	Loss of Signal indication. Logic 0 indicates normal operation [6]
9	RS1	No connection required [1]
10	VeeR	Receiver Ground (Common with Transmitter Ground) [1]
11	VeeR	Receiver Ground (Common with Transmitter Ground) [1]
12	RD-	Receiver Inverted DATA out. AC Coupled
13	RD+	Receiver Non-inverted DATA out. AC Coupled
14	VeeR	Receiver Ground (Common with Transmitter Ground) [1]
15	VccR	Receiver Power Supply

Pin	Symbol	Name/Description
16	VccT	Transmitter Power Supply
17	VeeT	Transmitter Ground (Common with Receiver Ground) [1]
18	TD+	Transmitter Non-Inverted DATA in. AC Coupled.
19	TD-	Transmitter Inverted DATA in. AC Coupled.
20	VeeT	Transmitter Ground

Notes:

- [1] Circuit ground is internally isolated from chassis ground.
- [2] T_{FAULT} is an open collector/drain output, which should be pulled up with a 4.7k - 10k Ohms resistor on the host board if intended for use. Pull up voltage should be between 2.0V to Vcc + 0.3V. A high output indicates a transmitter fault caused by either the TX bias current or the TX output power exceeding the preset alarm thresholds. A low output indicates normal operation. In the low state, the output is pulled to <0.8V.
- [3] Laser output disabled on T_{DIS} >2.0V or open, enabled on T_{DIS} <0.8V.
- [4] Should be pulled up with 4.7kΩ- 10kΩ host board to a voltage between 2.0V and 3.6V. MOD_ABS pulls line low to indicate module is plugged in.
- [5] Internally pulled down per SFF-8431 Rev 4.1.
- [6] LOS is open collector output. It should be pulled up with 4.7kΩ - 10kΩ on host board to a voltage between 2.0V and 3.6 V. Logic 0 indicates normal operation; logic 1 indicates loss of signal.

10 Recommended Interface Circuit

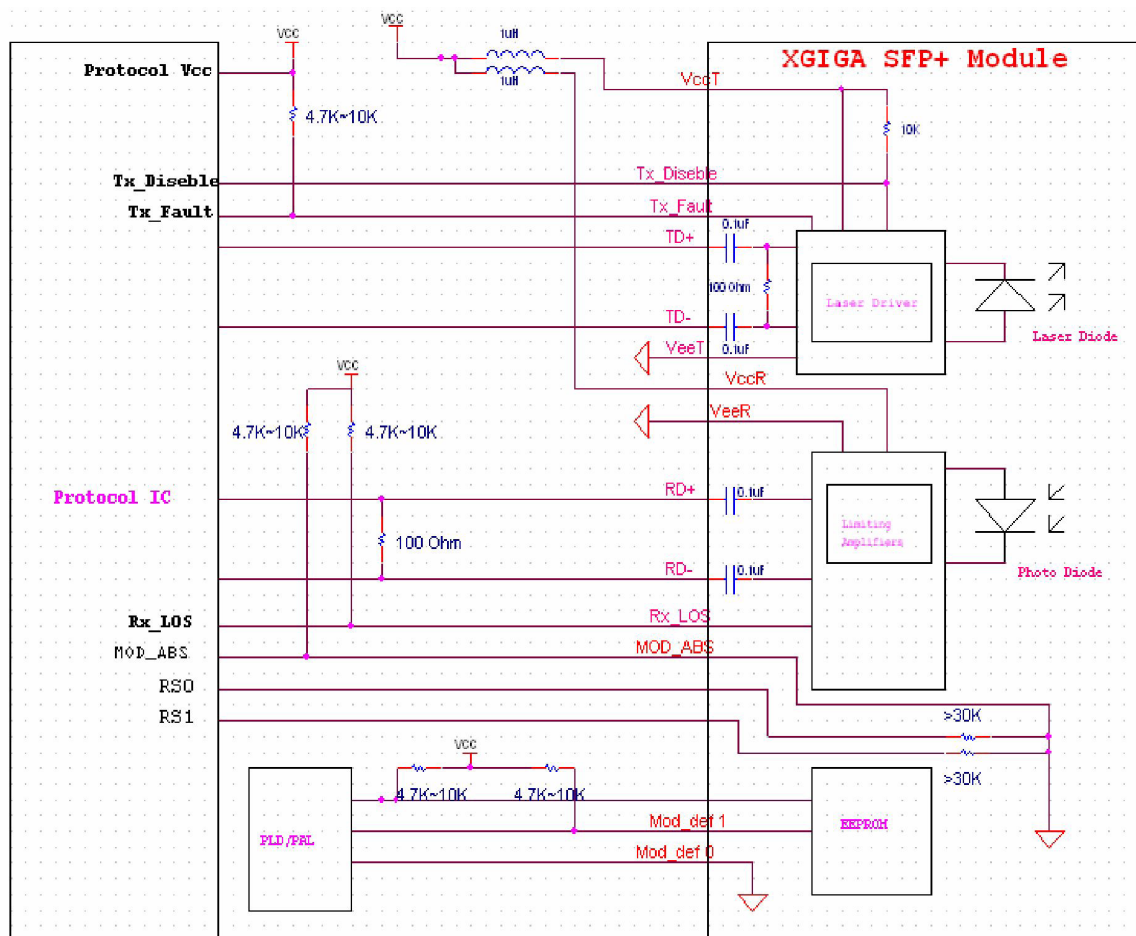

11. Outline Dimensions



Units in mm

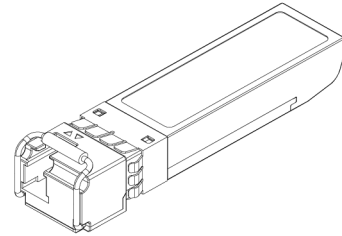
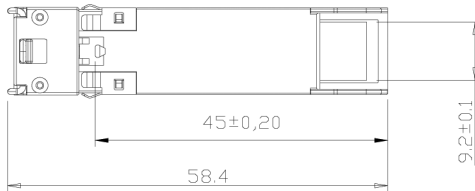
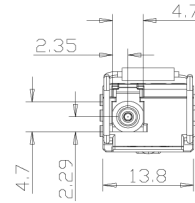
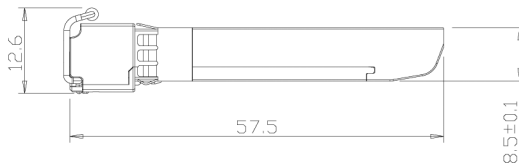

12. Regulatory Compliance

Feature	Reference	Performance
Electrostatic discharge (ESD)	IEC/EN 61000-4-2	Compatible with standards
Electromagnetic Interference (EMI)	FCC Part 15 Class B EN 55022 Class B (CISPR 22A)	Compatible with standards
Laser Eye Safety	FDA 21CFR 1040.10, 1040.11 IEC/EN 60825-1, 2	Class 1 laser product
Component Recognition	IEC/EN 60950, UL	Compatible with standards
ROHS	2002/95/EC	Compatible with standards
EMC	EN61000-3	Compatible with standards